



Non-penetrative supports for pipework, duct and cable ladder/tray

The H Frame Set is a quick, versatile and economical solution for supporting pipework, duct, cable ladders/trays or any combination of these. You provide your own strut, keeping the duct and pipe installations low-cost and totally flexible by fabricating the framework on-site.

The majority of installations require 305mm H Frames but where a greater load distribution is required 450mm and 600mm H Frames are also available.

H Frame Set 305mm

- Versatile application
- Quick & easy installation
- Excellent load distribution
- Compatible with industry standard componentry
- Interchangeable with 3 strut sizes – one foot fits all
- Supplied with adhered rubber mats for optimum roof protection
- Boxed for convenience



KIT INCLUDES

Feet with adhered mat	x 2
Brackets and fixings	x 4
Assembly instructions	x 1

FOOT FLEECEES

Recommended for use on PVC membrane roof surfaces to prevent polymer migration

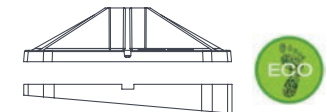

305 ANGLED MATS

2.5° and 5° rubber mats are also available for sloped roof applications



PLEASE NOTE: Strut NOT included

PRODUCT INFORMATION

Model	305mm	305mm 5 Pack
Part no.	B6088 	B9645 
Foot Size (mm)	305	305
Rec. frame load (kg)	300	300
Packaged weight (kg)	6.75	34

INTERCHANGEABLE STRUT

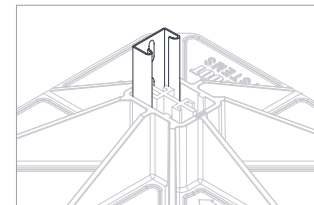

21 x 41 x 1.5mm Strut

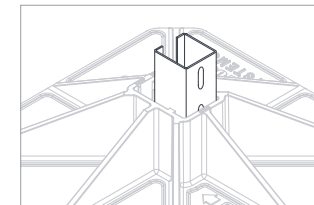

40 x 38 x 1.9mm Euro Strut

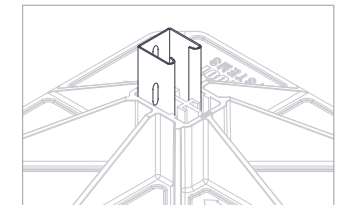

41 x 41 x 1.5mm Strut

H Frame Set 450mm & 600mm

- Versatile application
- Quick & easy installation
- Excellent load distribution
- Compatible with industry standard componentry
- Supplied with removable rubber mats for optimum roof protection
- Boxed for convenience

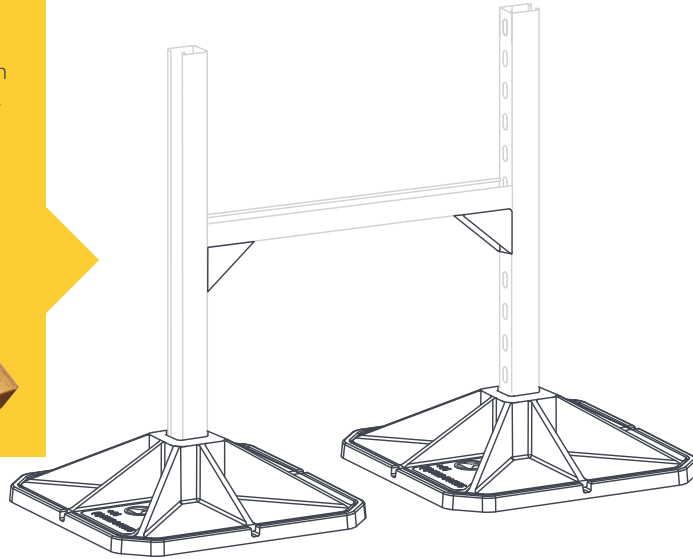

For ease of specification these products are detailed on the following building product libraries:



listed in
LUCKINSlive



KIT INCLUDES

Plastic feet	x 2
Rubber mats	x 2
Insert	x 2
Brackets and fixings	x 2
Assembly instructions	x 1

FOOT FLEECES

Recommended for use on PVC membrane roof surfaces to prevent polymer migration

450 ANGLED MATS

2.5° and 5° rubber mats are also available for sloped roof applications

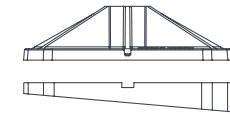

PLEASE NOTE: Strut NOT included

PRODUCT INFORMATION

Model	450mm	600mm
Part no.	B6089	B9222
Foot Size (mm)	450	600
Rec. frame load (kg)	500	500
Packaged weight (kg)	13.35	23.10

STRUT INSERT

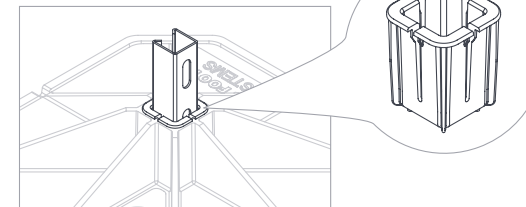

41 x 41 x 1.5mm Strut